

Instructions for use

KitchenAid

Installation diagrams	4
Important safety instructions	6
Safeguarding the environment	9
Eco design declaration	9
Before use	9
Existing pots and pans	9
Recommended pot bottom widths	9
Installation	10
Electrical connection	10
Instructions for use	11
After-Sales Service	16

Installation diagrams

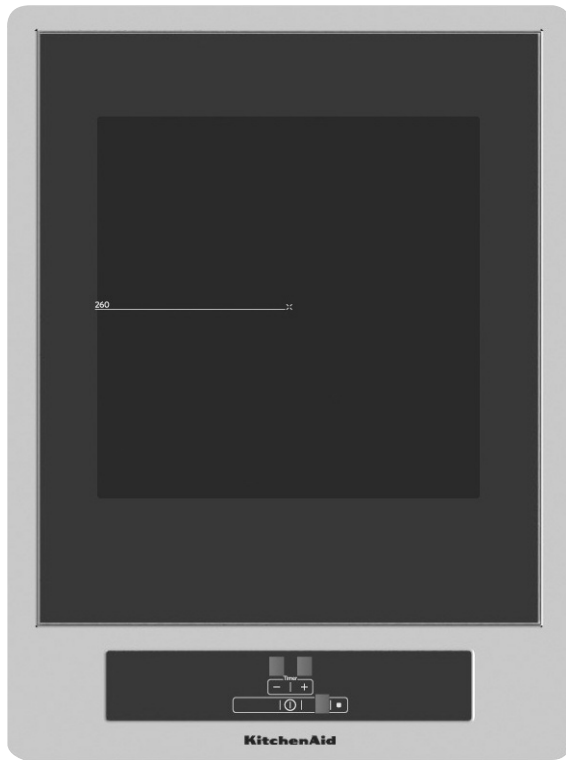

Installation diagrams

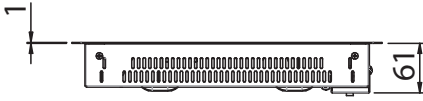

N.B. For the semi-flush mount version the 1.5 mm milling is not necessary.

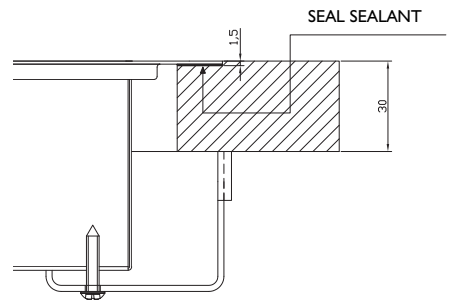
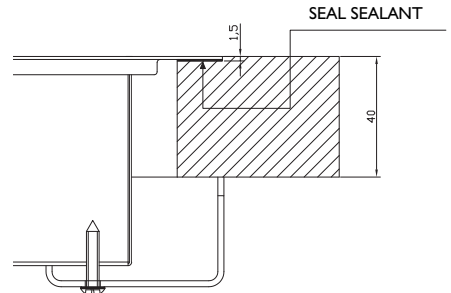
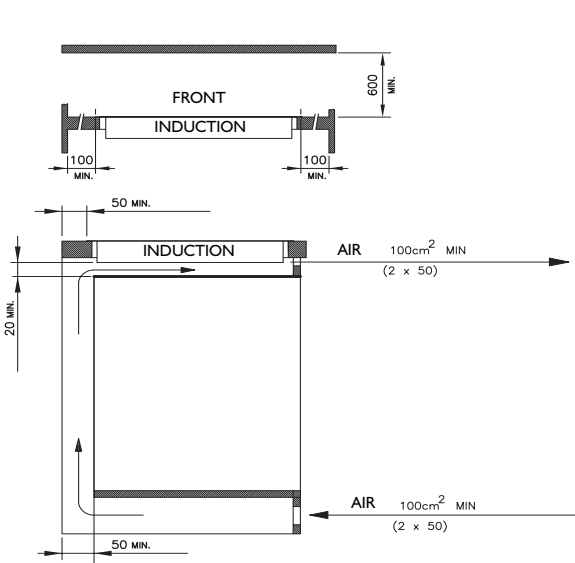
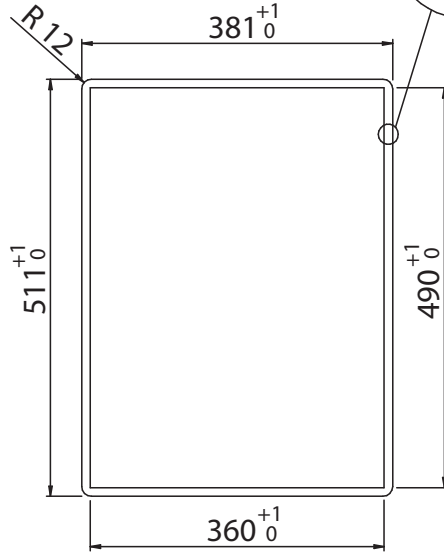
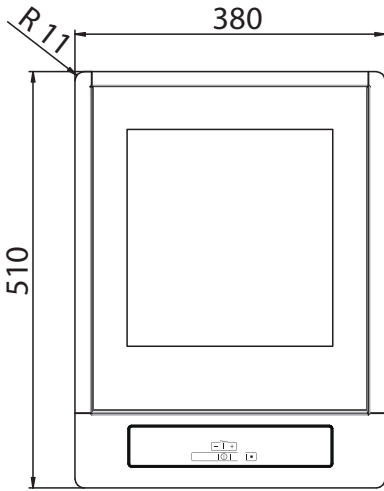
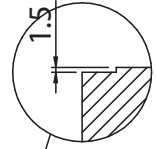

IMPORTANT SAFETY INSTRUCTIONS

YOUR SAFETY AND THAT OF OTHERS IS VERY IMPORTANT

This manual and the appliance itself provide important safety messages, to be read and always observed.



This is the danger symbol, regarding safety, warning of potential risks to users and others.

All safety messages will be preceded by the danger symbol and the following words:



DANGER

Indicates a hazardous situation which, if not avoided, will result in serious injury.



WARNING

Indicates a hazardous situation which, if not avoided, could cause serious injury.

All messages relevant to safety specify the potential risk to which they refer and indicate how to reduce the risk of injury, damage and electric shocks due to incorrect use of the appliance.

Make sure to comply with the following:

- Use protective gloves to perform all unpacking and installation operations.
- The appliance must be disconnected from the power supply before carrying out any installation operation.
- Installation and maintenance must be carried out by a specialised technician, in compliance with the manufacturer's instructions and the local safety regulations in force. Do not repair or replace any part of the appliance unless specifically stated in the user manual.
- The appliance must be earthed.
- The power cable must be long enough for connecting the appliance, fitted in the cabinet, to the power supply.
- For installation to comply with the current safety regulations, an omnipolar switch with minimum contact gap of 3mm is required.

- Do not use multi-sockets or extension cords.
- Do not pull the appliance's power cable.
- The electrical parts must not be accessible to the user after installation.
- The appliance is designed solely for domestic use for cooking food. No other use is permitted (e.g. heating rooms). The Manufacturer declines any liability for inappropriate use or incorrect setting of the controls.
- The appliance and its accessible parts become hot during use. Care should be taken to avoid touching heating elements. Very young (0-3 years) and young children (3-8 years) shall be kept away unless continuously supervised.
- Children from 8 years and above and persons with reduced physical, sensory or mental capabilities or lack of experience and knowledge can use this appliance only if they are supervised or have been given instructions on safe appliance use and if they understand the hazards involved. Children shall not play with the appliance. Cleaning and user maintenance shall not be made by children without supervision.
- Do not touch the appliance heating elements during and after use. Do not allow the appliance to come into contact with cloths or other flammable materials until all the components have cooled down completely.
- Do not place flammable materials on or near the appliance.
- Overheated oils and fats catch fire easily. Pay attention when cooking food products rich in fat and oil.
- A separator panel (not supplied) must be installed in the compartment under the appliance.
- If the surface is cracked, switch off the appliance to avoid the possibility of electric shock. (only for appliances with glass surface).
- The appliance is not intended to be operated by means of an external timer or separate remote control system.
- Unattended cooking on a hob with fat or oil can be dangerous and may result in fire. NEVER try to extinguish a fire with water, but switch off the appliance and then cover flame e.g. with a lid or a fire blanket.

Danger of fire: do not store items on the cooking surfaces.

- Do not use steam cleaners.
- Metallic objects such as knives, forks, spoons and lids should not be placed on the hob surface since they can get hot.
- After use, switch off the hob element by its control and do not rely on the pan detector. (only for appliances with glass surface).

Disposal of household appliances

- This product is built from recyclable or reusable materials. Disposal must be carried out in accordance with local regulations for waste disposal. Before scrapping, cut off the power supply cable.
- For further information on the treatment, recovery and recycling of household appliances, contact the competent local authority, the domestic waste collection service or the shop where you purchased the product.

Safeguarding the environment

Disposal of packing

The packing material is 100% recyclable and marked with the recycling symbol . The various parts of the packing must not be dispersed in the environment, but disposed of in compliance with local regulations.

Disposal

This appliance is marked in conformity with European Directive 2012/19/EU on Waste Electrical and Electronic Equipment (WEEE). By ensuring that this appliance is correctly disposed of, the user can help prevent potentially negative consequences for the environment and the health of people.



The symbol  on the appliance or the accompanying documentation indicates that this product should not be treated as domestic waste but must be taken to an appropriate collection point for recycling WEEE.

Energy saving tips

For optimum results, it is advisable to:

- Use pots and pans with bottom width equal to that of the cooking zone.
- Only use flat-bottomed pots and pans.
- When possible, keep pot lids on during cooking.
- Use a pressure cooker to save even more energy and time.
- Place the pot in the middle of the cooking zone marked on the hob.

Eco design declaration

This appliance meets the eco design requirements of European regulation N. 66/2014, in conformity to the European standard EN 60350-2.

Before use

IMPORTANT: The cooking zones will not switch on if pots are not the right size. Only use pots bearing the symbol “INDUCTION SYSTEM” (Figure opposite). Place the pot on the required cooking zone before switching the hob on.



Existing pots and pans

Use a magnet to check if the pot is suitable for the induction hob: pots and pans are unsuitable if not magnetically detectable.

- Make sure pots have a smooth bottom, otherwise they could scratch the hob. Check dishes.
- Never place hot pots or pans on the surface of the hob's control panel. This could result in damage.

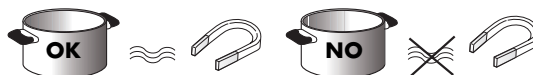

Recommended pot bottom widths

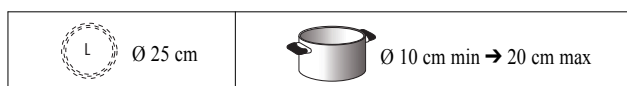

Installation

After unpacking the product, check for any damage during transport.

In case of problems, contact the dealer or the After-Sales Service.

For built-in dimensions and installation instruction, see the pictures in page 5.

PREPARING THE CABINET FOR FITTING

WARNING

- **The lower part of the product must not be accessible after installation.**
- **Do not fit the separator panel if an undertop oven is installed.**

These instructions are aimed at qualified fitters as a guide to installation, adjustment and maintenance in compliance with the laws and standards in force. The operations must always be carried out with the appliance disconnected from the electricity supply.

Positioning

The appliance is made to be fitted into a counter top, as show in the figure. Apply the sealant supplied around the whole perimeter of the hob. Installation over an oven is not recommended, but if this is necessary, check that:

- the oven has an efficient cooling system;
- there is no passage of hot air from the oven to the hob;
- allow air passages as shown in the figure.

If needing to install multiple Domino products in the same cut-out, the Domino Connector (not included) accessory must be purchased separately from the After-sales Service.

In addition, also order special kit 480121103229 in case of installation in a stone counter top.

Electrical connection

WARNING

- **Disconnect the appliance from the power supply.**
- **Installation must be carried out by qualified personnel who know the current safety and installation regulations.**
- **The manufacturer declines all liability for injury to persons or animals and for damage to property resulting from failure to observe the regulations provided in this chapter.**
- **The power cable must be long enough to allow the hob to be removed from the worktop.**
- **Make sure the voltage specified on the dataplate located on the bottom of the appliance is the same as that of the home.**

Before connecting to the electricity supply, ensure that:

- the characteristics of the system are such as to satisfy that indicated on the registration plate applied to the bottom of the hob;
- the system has an effective earth connection compliant with the standards and laws in force. Connection to earth is compulsory by law.

If the appliance has no cable and/or plug, use material suitable for the absorption indicated on the registration plate and for the working temperature. The cable must not reach a temperature higher than 50°C above room temperature in any point.

Electrical connection

For direct connection to the network it is necessary to fit an omnipolar switch of a suitable size to ensure disconnection of the network with a contact opening distance that allows complete disconnection in the conditions of the overvoltage category III, compliant with the installation regulations (the yellow/green earth wire must not be interrupted).

The omnipolar socket or switch must be easy to reach when the appliance is installed.

N.B.:

- The manufacturer declines all responsibility if the usual accident prevention standards and the above instructions are not observed.

If the power cable is damaged, it must be replaced by the manufacturer or by the manufacturer's technical servicing network, or by a similarly qualified operator, to prevent every possible risk.

Connection to the terminal block

For the electrical connection, use an H05RR-F or H05 VV-F cable as specified in the table below.

Wires	Number x size
220-240 V ~ + ⊕	3 x 1.5 mm ²

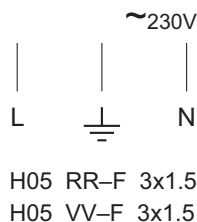

Instructions for use

Operating principle

This is based on the electromagnetic properties of most cooking containers.

The electronic circuit governs the operation of the coil (inductor), creating a magnetic field.

The heat is transmitted by the container to the food.

The cooking process takes place as follows:

- minimum dispersion (high performance);
- the removal of the pan (simply lifting it) automatically stops the system;
- the electronic system allows maximum flexibility and precision of regulation.

Installation

All installation operations (electrical connection) must be carried out by people qualified in compliance with the laws in force.

For specific instructions, see the installation section.

Important: This apparatus is not suitable for use by person (children included) with reduced mental and physical capacity or with lack of experience and knowledge unless having previously received suitable training for its use by persons responsible for their safety.

It must be ensured that children do not play with the apparatus.

Use

First of all, position the pan in the chosen cooking area.

The absence of the pan display  means the system cannot start.

Instructions for use

On/off of the Touch Control

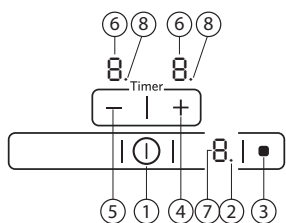

1. On/off
2. Selection decimal points or association with the timer
3. Cooking area selection
4. Power increase
5. Power decrease
6. Timer display
7. Cooking point display
8. Selection decimal points or association with the timer

The electronic Touch Control is activated by means of the ON/OFF button and switches from the OFF mode to the Standby mode.

To do so it is necessary to press the ON/OFF button for 1 second. A short Beep will be heard.

When in standby, "0" is displayed on the display of the cooking zone.

This display may go into background due to a residual heat or error signal.

If a cooking zone is activated during the standby time (10 sec.), the control switches over to the On mode.

If no introduction is made within the 10 sec., the control automatically switches to OFF with a short beep.

The electronics can be switched to the OFF mode at any time during the ON mode or the Standby mode by pressing the ON/ OFF button. The Off function has priority when operating, meaning that the control switches off even by activating several buttons at the same time.

Switching on a cooking zone

To begin using the product, turn on the cooking surface from the main O/I switch and use a suitable pan.

The touch control works on the principle of selection. The cooking point to be used must first be selected before setting the power level with the "+/ -" keys. The display of a selected cooking point is brighter and the decimal point of the display lights up.

Switching off a cooking zone

- a) Selecting cooking level "0" of the desired cooking zone with the "-" button
- b) Selecting the cooking area and then, simultaneously pressing the minus button and the cooking area selection button.
- c) Pressing the main O/I switch again turns the control off (all cooking points together) with a single touch.

If the last cooking zone is switched off, the control switches to the OFF mode after 10 sec. if nothing else is switched on.

All cooking zones are switched off immediately by pressing the ON/OFF button.

Cooking and power levels

The cooking and power levels of the cooking zones are shown on the display with 7 allotted segments. The power of the cooking points can be adjusted to 9 levels and is displayed using numbers "1" to "9"; in addition, the letter is "P" is displayed when the Booster function is activated.

Residual heat indicator

Indicates to the user that the glass is at a dangerous temperature if in contact with the area over the cooking zone. The temperature is determined by means of a mathematical model and possible residual heat is indicated by "H" on the corresponding 7 segment display.

Heating and cooling are calculated based on:

- The selected power level (from "0" to "9");
- The relay activation time after the cooking zone has been switched off.

The corresponding display shows "H" until the zone temperature drops below the critical level (< 60 °C) according to the mathematical model.

Instructions for use

Automatic power down (limiting the working time)

The limitation of the working time is a function of the touch control, for turning off the generator. In relation to the cooking level set, each cooking point is turned off after a certain maximum operating time unless the set cooking time has been changed.

Any change in the status of the cooking point with these assigned keys resets the maximum operating time of that cooking point to the starting value of the limitation of the operating time.

POWER LEVELS	OPERATING TIME LIMIT (MINUTES)
1	480
2	360
3	300
4	300
5	240
6	90
7	90
8	90
9	90
P	0

Timer function

The Timer function can be used as a timer for the cooking point or as an independent alarm clock.

The two 7 segment displays of the respective cooking zones are used to view the remaining time in minutes up until the timer alarm is activated.

Timer selection

The timer value is displayed on the display behind the cooking points.

There are two different time modes:

- Timer for the cooking point: the timer is assigned to a cooking point. When the set time runs out, there is an audible and visual signal and the relative cooking point turns off.
- alarm for cooking: the timer works independently from the cooking point. When the set time runs out, there is an audible and visual signal in this mode as well, but the cooking points are not turned off.

Selecting a timer:

a timer is selected by simultaneously pressing the plus and minus keys with the control activated.

If you have previously selected a cooking point, the timer of that cooking point will light up. Plus, this will be indicated by the flashing decimal point on the display of the cooking point.

If no cooking point had been previously selected, the cooking alarm timer will be activated. In this case, all the decimal points will be off.

If different timers are active, you can select the desired timer by pressing the plus and minus keys several times.

If a timer was set for the cooking point and also a generic timer, when the selection time has elapsed (10 seconds) the timer with less time is shown on the upper display so, if a timer of, for example, 1 minute was set on the cooking area and the generic cooking timer was set for 2 minutes, 01 will be displayed and the selection decimal point will continue flashing. Conversely, if the cooking area timer was set to, for example, 4 minutes and the generic cooking timer was set to 3 minutes, the timer will display 03 and the selection decimal point of the cooking area will remain on to indicate that a timer is set.

The selection time is 10 seconds. This time is set from scratch at each change of the value of the timer by pressing the plus or minus key.

You can end the selection early by selecting a cooking point.

Instructions for use

Setting the timer value:

when a timer has been selected, you can change the timer value using the plus or minus keys. If a timer value has not been set, pressing the minus key will set a value of 30 minutes, which can then be changed. By holding down the plus or minus key longer, the set value will change faster. At a setting value of 99 or 01, the automatic repeat will automatically stop.

Turning off the timer early:

You can turn off the timer by setting the timer value to 00.

In the case of a cooking point timer, the corresponding cooking point will stay on.

Counting down the time set on the timer:

the time countdown starts as soon as a timer is set. If the value is changed using the plus or minus keys, the timer starts on a full minute and any seconds that may have elapsed are cancelled.

Signal of a timer whose set time has run out:

If the timer value has reached 00, this will be indicated by an audible and visual signal. If a cooking point timer has reached the set value, the corresponding cooking point will be turned off. Any cooking points or timers selected will be deselected.

The timer value (00) is automatically displayed again and flashes. If it is a cooking point timer, the corresponding decimal point will also flash. The signal lasts for 2 minutes, unless it is stopped earlier by pressing any key.

After the signal, all the active cooking point displays will be visible again.

Control panel lock

Locking/activating control panel lock:

The control panel lock prevents accidental power-on. It can be activated when none of the cooking points and on.

Locking:

You can activate the control panel lock after turning on the control.

To do this, you must simultaneously press the Front Right cooking point selection key and the MINUS key and then press the Front Right cooking point selection key again. The "L", for LOCKED, will appear on all the displays. If a cooking point is "hot", the display will flash with an alternating "L" and "H". This sequence of commands must be entered within 10 seconds and no other keys than those described must be pressed, otherwise the activation will not be completed.

The control will remain locked until it is unlocked, even if it is turned off and on. A mains power failure does not cancel the lock.

Temporary unlocking for cooking:

To unlock the control, you must simultaneously press the Front Right cooking point selection key and the MINUS key. The letter "L", for LOCKED, will disappear and all the displays will show "0" with a flashing point. If one of the cooking points is "hot", a flashing "0" and "H" will alternate with a flashing point.

After the control is turned off, the child lock will be active again.

Total deactivation of the lock:

You can disable the control panel lock after turning on the control. To do this, you must simultaneously press the Front Right cooking point selection key and the MINUS key and then press the MINUS key again. After you have entered the correct key sequence within 10 seconds, the lock will be deactivated and the control will go into STANDBY, otherwise the entry will be considered incomplete and the control will remain locked and will turn off after 20 seconds.

Booster

The boost function can be activated, for cooking points that have this option, when they have previously been set to cooking level "9", the respective cooking point has been selected and the plus key pressed again.

It is only possible to activate the boost function if the induction module allows it (there are special temperature limits in the generator for the boost function). If the booster function is allowed on the desired cooking point, a "P" appears on the display.

Instructions for use

The power required to activate the booster function could be too high and, as a result, the integrated powermanagement feature will reduce the power of the other cooking point of the same induction module; this is indicated to the user by the flashing of the assigned display, allowing a correction time of 3 seconds before the power is reduced to the necessary cooking level.

For each cooking point, the Booster function lasts 5 minutes.

Precautions

- If there is even the tiniest crack in the ceramic glass surface, immediately disconnect the hob from the electricity supply.
- During operation, move any magnetic materials such as credit cards, computer disks, calculators, etc., away from the area.
- Never use cooking foil or rest products wrapped in foil directly on the hob.
- Metallic objects such as knives, forks, spoons and lids must not be rested on the surface of the hob to prevent them from heating up.
- When cooking with non-stick containers, without using water or oil, limit any preheating time to one or two minutes.
- When cooking foods which tend to stick to the bottom of the pan, start at minimum power and gradually increase the heat, stirring frequently.
- After use, switch off correctly (decreasing to “0”) and avoid relying on the pan sensor.

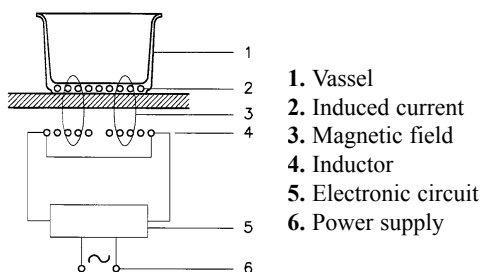

Pans

- If a magnet is attracted by the bottom of a container, the container is suitable for induction cooking;
- prefer pans declared as suitable for induction cooking;
- flat, thick-bottomed pans;
- a 20 cm diameter saucepan can benefit from maximum power;
- a small saucepan reduces the power but will not cause energy dispersion. The use of containers with a diameter of less than 10 cm is not recommended;
- stainless steel containers with multilayer bottom or ferrite stainless steel if the bottom indicates: for induction;
- cast iron containers, better with an enamelled bottom to avoid scratching the ceramic glass hob;
- containers made of glass, ceramic, terracotta, aluminium, copper or non-magnetic stainless steel (austenitic) are not recommended and are unsuitable.

The pan to use with the wok induction model must be semi spherical.

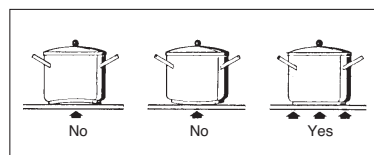

Maintenance

By means of a scraper immediately remove any aluminium foil bits, food spills, grease splashes, sugar marks and other high sugar-content food from the surface in order to avoid damaging the hob. Subsequently clean the surface with some paper towel and SIDOL or STANFIX, rinse with water and dry by means of a clean cloth.

Under no circumstance should sponges or abrasive cloths be used; also avoid using aggressive chemical detergents such as oven sprays and spot removers.

DO NOT USE STEAM CLEANERS

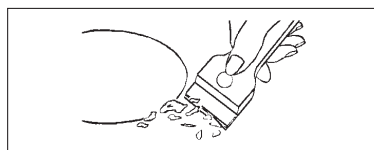

After-Sales Service

Before contacting the After-Sales Service

1. Switch the appliance off and then on again it to see if the problem has been eliminated.

If the problem persists after the above checks, contact the nearest After-Sales Service.

Always specify:

- a brief description of the fault;
- the product type and exact model;
- the Service number (the number after the word Service on the rating plate), located under the appliance (on the metal plate).
- your full address;
- your telephone number.

SERVICE 0000 000 00000



If any repairs are required, contact an authorised After-Sales Service Centre (to ensure the use of original spare parts and correct repairs). Spare parts are available for 10 years.



FOR THE WAY IT'S MADE.

Whirlpool EMEA S.p.A.
Via Carlo Pisacane n.1,
20016 Pero (MI), Italy
www.whirlpool.eu

Printed in Italy
Q 10/16

400010902982

